

Digital Anemometer Instruction Manual



Attention: Anemometer App only supports Android 5.0 version or above.

Apple APP is not available yet, please pay close attention to our company for details.

Please scan the QR code to download the App from Google Play.

Version: WT87B-EN-00

A. Function

1. Measurement of wind speed and temperature
2. Wind cold indicator
3. Switch wind speed units
4. Real-time measurement of wind speed and average wind speed
5. Measurement of maximum wind speed and minimum wind speed
6. Switch between Fahrenheit and Celsius unit
7. Timed automatic shutdown (automatic shutdown after 10mins of no button operation)
8. LED lighting
9. Measurement of air volume
10. USB communication (with computer applications)
11. Bluetooth communication (with mobile APP)

B. Instruction of parts and LCD display

(1). Instruction of parts (as shown in picture)

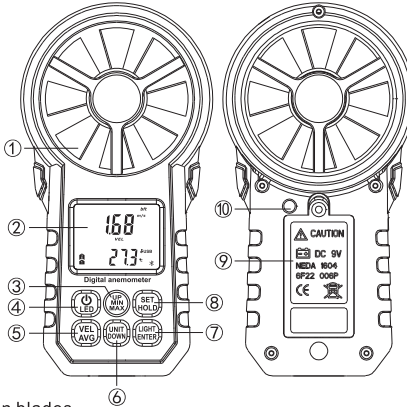

- ①. Fan blades
- ②. LCD display
- ③. Up/Maximum/Minimum mode
- ④. Power/backlight
- ⑤. Average wind speed measurement
- ⑥. Switch of wind speed units/Down
- ⑦. LED lighting/Confirmation
- ⑧. Data holding/Setting
- ⑨. Battery door
- ⑩. LED lighting

(2). Instruction of LCD display (as shown in picture)

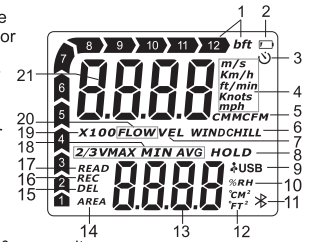

1. Beaufort wind scale
2. Low battery indicator
3. Timing automatic shutdown indicator
4. Wind speed unit
5. Air volume unit
6. Wind cold indicator
7. Wind speed icon
8. Data holding
9. USB
10. Humidity unit
11. Bluetooth icon
12. Temperature unit & area unit
13. Temperature display area
14. Area value
15. Delete records
16. Start recording
17. Read records of instrument
- 18) Two-thirds of maximum wind speed/maximum/minimum /average wind speed
- 19) X10 times, X100 times (X10 appears when the value exceeds 99.99, X100 appears when the value exceeds 999.99)
- 20) Air volume icon
- 21) Wind speed / air volume display area

C. Operation instruction

- 1. Power on/off:**
After installing batteries, press "⏻" button to turn on the instrument, LCD display comes in full screen for 1s, and the buzzer lets out two beeps (if the buzzer is on); the instrument enters normal measurement mode of real-time wind speed and temperature. Long press "⏻" button for at least 2s to turn it down.
- 2. LCD backlight:**
After powering on, press "⏻" button to turn on/off LCD backlight.
- 3. Maximum/minimum mode:**
Under normal mode, press "⏮" button to enter measurement mode, which measures maximum and minimum wind speed in real time. Short press "⏮" button again to return to normal mode.
- 4. Data holding:**
Under normal mode, press "⏸" button to hold wind speed value when "HOLD" appears on the LCD; short press "⏸" button again to return to normal mode.

5. Measurement of average wind speed:

Under normal mode, short press "⏮" button to switch to measurement of average wind speed, which is the average value of 30 current wind speed values, and "AVG" icon appears on the LCD; short press "⏮" button again to return to normal mode.

6. Selection of wind speed unit:

Short press "⏮" button to select different wind speed unit in turn.

7. LED lighting:

Under normal mode, short press "⏻" button to turn on/off LED lighting.

8. Setting of temperature unit:

Long press "⏸" button for 2s to enter setting mode; "ELE" icon appears on display area of wind speed, indicating that the temperature measurement mode is on. Short press "⏮" to switch to Fahrenheit unit, short press "⏭" to switch to Celsius unit and the corresponding temperature value will display. Long press "⏸" button for 2s to save setting and return to normal mode. (the setting is automatically saved if the instrument shuts down)

9. Automatic shutdown setting:

Long press "⏸" button for 2s to enter setting mode. short press "⏸" button again until "OFF" appears on display area of wind speed, indicating that automatic shutdown setting is on. Short press "⏮" button to turn on timing shutdown, and short press "⏮" button to turn off timing shutdown. Long press "⏸" button for 2s to save setting and return to normal mode. (the setting is automatic saved if the instrument shuts down)

10. Buzzer setting:

Long press "⏸" button for 2s to enter setting mode. Short press "⏸" button twice to until "bu2" appears on display area of wind speed, indicating that the buzzer setting is on. Short press "⏮" button to turn on buzzer, short press "⏮" button to turn off buzzer. Long press "⏸" button for 2s to save setting and return to normal mode. (the setting is automatically saved if the instrument shuts down)

11. Bluetooth setting:

Long press "⏸" button for 2s to enter setting mode. Short press "⏸" button for three times until "bLE" appears on the display area of wind speed, indicating that automatic shutdown setting is on. Short press "⏮" button to close Bluetooth with "CLO", short press "⏮" button to open Bluetooth with "OPE"; long press "⏸" button for 2s to save setting and return to normal mode. When Bluetooth is on, mobile APP searches for a source named "Anemometer" for

connection. After the connection is successful, the icon "✳" of Bluetooth changes from blinking to continuous display, and it flashes again due to disconnection. (It is advised to turn off Bluetooth to save power)

12. View/record/set/delete records of wind speed value;

Long press "⏸" button for 2s to enter viewing mode of wind speed records. The number of records appears on the display area of temperature. Short press "⏮" to page down, short press "⏭" to page up, the display area of wind speed will show wind speed value recorded at the time with corresponding unit and Beaufort wind scale. (better to set in the APP) Under this interface:

A. Long press "⏸" button for 2s to enter setting mode of recording interval. "----" appears on the display area of wind speed, and the time interval of the last setting appears on the display area of temperature. Short press "⏮" to select setting, short press "⏮" to add 1, short press "⏭" to deduct 1, and the maximum setting value is 9999; long press "⏸" button for 2s to save setting and return to viewing mode.

B. Long press "⏮" button for 2s to enter record deleting mode. Total number of records appears on the display area of temperature displays. At this time:

① Short press "⏮" button to delete all records of wind speed values and return to viewing mode. "----" appears on the display area of wind speed, and "0" appears on the display area of temperature.

② If you do not want to delete records, long press "⏮" button for 2s to return to viewing mode.

C. Short press "⏻" button to start recording and saving data, with "rec" flashing.

D. When records are full, "Full" icon appears, and you need to manually delete records as Step B.

13. Air volume display setting:

Long press "⏮" button for 2s to enter air volume display mode. The current air volume value appears on the display area of wind speed, and the current set area value appears on the display area of temperature. At this time:

A. Long press "⏸" button for 2s to enter setting mode of area value. Short press "⏮" to select setting, short press "⏮" to add 1, short press "⏭" to deduct 1, and the maximum setting value is 9999; long press "⏸" button to adjust position of decimal point, and long press "⏸" button for 2s to save setting and return to display mode of air volume.

B. Long press "⏮" button for 2s to return to display mode of wind speed.

- A. Short press "⏮" button and "2/3VMAX" appears, indicating that the current air volume value is 2/3 of the maximum value. Short press to return to normal reading value under display mode of air volume.
- B. Short press "⏮" button to switch between maximum and minimum mode of air volume.
- C. Short press "⏮" button to switch between CMM /CFM —M2/FM2.
- D. Short press "⏸" button to hold data.

D.USB communication (with computer application)

Before using USB,pls enter the website www.wintact.net in the browser, press the "Enter" key on the keyboard to enter the page and find the menu "Support > Download",as shown in figure 1;Click into the page to find the software installation package "setup_AnemometerMK25.Zip",as shown in figure2; Click "button to download. After downloading, directly unzip the "zip package". Before installing the software, please carefully read the "required reading before use" document in the software installation package,and then install it.

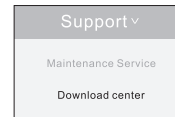

Figure 1

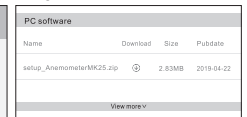

Figure 2

1. After starting software, first connect to port and turn on the instrument.

The current connection state of the instrument will be indicated in the lower left corner. Start page: Real-time measurement: Enter real-time measurement interface.



2. Software interface description:

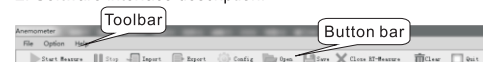

3. Toolbar description:

Read meter value interval (set a few seconds to read the value of the meter measurement)

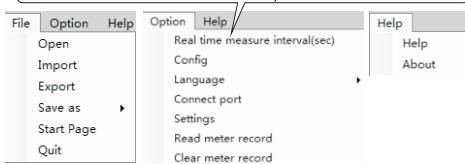

4. Settings interface description:

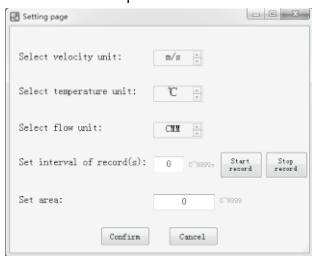

5. Display area: as the instrument switches wind speed ↔ air volume, the display area shows correspondingly (so does line chart).
Line chart: Figure 1 is wind speed / air volume chart, Figure 2 is temperature / humidity chart.
List: recording the data passed by the instrument, which can import and export data (data can be saved in two formats: ane/.xls).

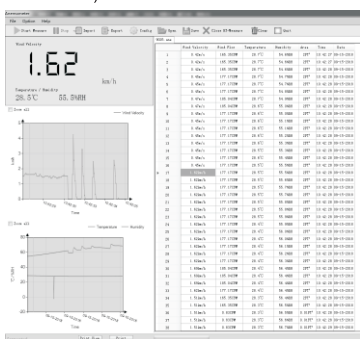

-06-

6. Configuration page description:

The contents of window that pops out after clicking configuration button in button bar will be displayed in the exported EXCEL.

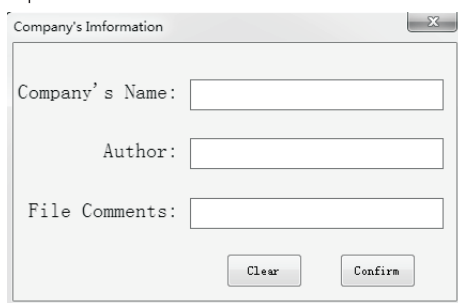

7. Status bar: The status of the operation process will be presented in the bottom column; Print button: printing the current page.



NOTE:

1. After successful installation, the default language at first is English, which can be changed by user.

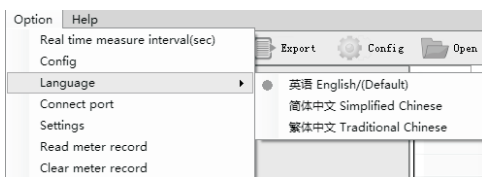

2. Click on line chart area for labels of current X and Y axis, drag and drop for enlarged image, and double-click to return to the previous state.
3. Click on any cell in the list for labels of X and Y axis in line chart.

-07-

E. APP operation instruction

- Bluetooth connection interface:
1) Before Bluetooth is connected, click start button or reset button on home page for Bluetooth connection window.
2) Click on the search icon in the upper right corner of window to search for Bluetooth device, which takes about 5s.
3) Click on the device to connect.

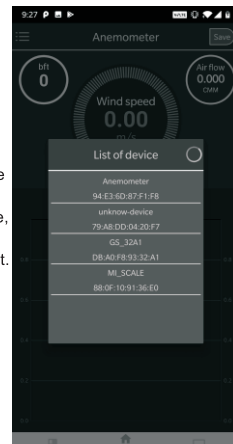

- Home page interface:
1) Button in upper left corner: Enter setting interface.
2) Storage button in upper right corner: Save real-time data.
3) Start button: Perform real-time data sampling.
4) Reset button: Clear real-time sampled data.
5) The upper half of interface is real-time data display, green numbers are values of wind speed, and yellow numbers are values of temperature and humidity.
6) The lower half of interface is a real-time wind speed curve.



-08-

3. Real-time data list interface:



4. Saved data interface:

- Short press to enter data display interface.
- Long press to choose data to be deleted.
- Gray icon stands for the data read from lower computer (anemometer).
- Blue icon stands for the real-time saved data.

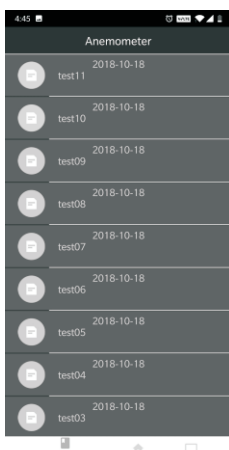

-09-

5. Data display interface:

- Wind speed curve, temperature and humidity curve and data list are displayed in the interface.
- Upper right button: Export data, the data is exported to mobile phone in the form of EXCEL.

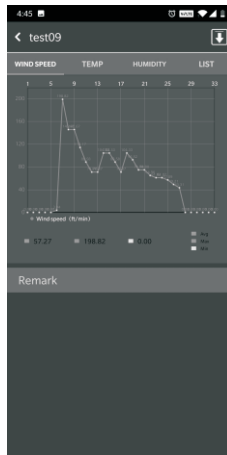

6. Settings interface:

- Unit setting: air volume area setting and time interval setting of data storage.
- Start recording: control lower computer to start recording.
- End recording: Control lower computer to end recording.
- Read record: Read the data saved by lower computer.
- Delete record: delete the data saved by lower computer.

Note: Lower computer: anemometer

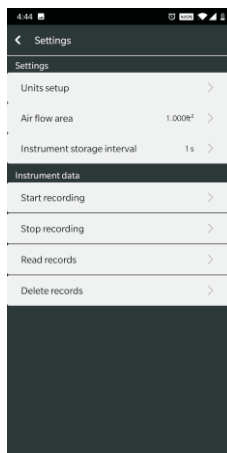

-10-

F. Technical Parameters

A. Wind velocity measurement				
Unit	Measurement range	Resolution	Threshold	Accuracy
m/s	0~30	0.01	0.3	±5% ±0.1
ft/min	0~5860	1.968	60	±5% ±0.2
knots	0~55	0.019	0.6	±5% ±0.2
km/h	0~90	0.036	1	±5% ±0.4
mph	0~65	0.022	0.7	±5% ±0.2

B. Wind flow range :			
CMM: 0-999900m ³ /min		CFM: 0-999900ft ³ /min	
Unit	Range	Resolution	Area
CFM(FT ³ /MIN)	0-999900	0.001-100	0.001-9999
CMM(M ³ /MIN)	0-999900	0.001-100	0.001-9999

C. Wind temperature measurement			
Unit	Measurement range	Resolution	Accuracy
°C	-10°C~+45°C	0.1	±2°C
°F	14°F~113°F	0.2	±3.6°F

Battery	9V battery (6F22)		
Temperature sensor	Negative Temperature Coefficient Resistance		
Operation temperature	-10°C~+45°C(14°F~113°F)		
Operation humidity	Less than 90%RH		
Storage temperature	-10°C~+50°C(14°F~122°F)		
Current consumption	About 6mA with Bluetooth on: 16mA		
Weight	186g(including battery)		
Size	165x85x39mm		

Specific Declarations:
Our company shall hold no any responsibility resulting from using output from this product as an direct or indirect evidence. We reserves the right to modify product design and specification without notice.



-11-